

# Installation, Operation, and Maintenance Manual

8121.210 Micro





---

# Table of Contents

<b>Introduction and Safety</b> .....	3
Introduction.....	3
Safety terminology and symbols.....	3
Inspect the delivery.....	4
Inspect the package.....	4
Inspect the unit.....	4
Product warranty.....	4
Safety.....	5
User safety.....	6
Hazardous liquids.....	6
Wash the skin and eyes.....	6
Environmental safety.....	7
<b>Transportation and Storage</b> .....	8
Transportation guidelines.....	8
Precautions.....	8
Position and fastening.....	8
Lifting.....	8
Storage guidelines.....	8
Storage location.....	8
Freezing precautions.....	8
Long-term storage.....	9
<b>Product Description</b> .....	10
Products included.....	10
Pump design.....	10
Monitoring equipment.....	10
Level regulators.....	10
The data plate.....	11
<b>Installation</b> .....	13
Install the pump.....	13
Sedimentation prevention.....	13
Discharge line requirements.....	13
Fasteners.....	14
Install.....	14
Make the electrical connections.....	15
General precautions.....	15
Requirements.....	15
Cables.....	16
Earthing (Grounding).....	16
Check the earth (ground) continuity.....	16
Electrical connection.....	17
Check the impeller rotation.....	18
<b>Operation</b> .....	20
Precautions.....	20
Distance to wet areas.....	20
Noise level.....	20
Start the pump.....	20
Clean the pump.....	21

<b>Maintenance</b> .....	22
Precautions.....	22
Maintenance guidelines.....	22
Torque values.....	22
Service.....	23
<b>Troubleshooting</b> .....	24
Introduction.....	24
The pump does not start.....	24
The pump does not stop when a level sensor is used.....	25
The pump starts-stops-starts in rapid sequence.....	25
The pump runs but the motor protection trips.....	26
The pump delivers too little or no water.....	26
<b>Technical Reference</b> .....	28
Application limits.....	28
Motor data.....	28
Specific motor data.....	28
Dimensions and weights.....	29
Performance curves.....	29

# Introduction and Safety

## Introduction

### Purpose of this manual

The purpose of this manual is to provide necessary information for:

- Installation
- Operation
- Maintenance



### CAUTION:

Read this manual carefully before installing and using the product. Improper use of the product can cause personal injury and damage to property, and may void the warranty.

### NOTICE:

Save this manual for future reference, and keep it readily available at the location of the unit.



## Safety terminology and symbols

### About safety messages

It is extremely important that you read, understand, and follow the safety messages and regulations carefully before handling the product. They are published to help prevent these hazards:

- Personal accidents and health problems
- Damage to the product
- Product malfunction

### Hazard levels

Hazard level	Indication
 <b>DANGER:</b>	A hazardous situation which, if not avoided, will result in death or serious injury
 <b>WARNING:</b>	A hazardous situation which, if not avoided, could result in death or serious injury
 <b>CAUTION:</b>	A hazardous situation which, if not avoided, could result in minor or moderate injury

Hazard level	Indication
<b>NOTICE:</b> 	<ul style="list-style-type: none"> <li>• A potential situation which, if not avoided, could result in undesirable conditions</li> <li>• A practice not related to personal injury</li> </ul>

### Hazard categories

Hazard categories can either fall under hazard levels or let specific symbols replace the ordinary hazard level symbols.

Electrical hazards are indicated by the following specific symbol:



#### Electrical Hazard:

These are examples of other categories that can occur. They fall under the ordinary hazard levels and may use complementing symbols:

- Crush hazard
- Cutting hazard
- Arc flash hazard

## Inspect the delivery

### Inspect the package

1. Inspect the package for damaged or missing items upon delivery.
2. Note any damaged or missing items on the receipt and freight bill.
3. File a claim with the shipping company if anything is out of order.  
If the product has been picked up at a distributor, make a claim directly to the distributor.

### Inspect the unit

1. Remove packing materials from the product.  
Dispose of all packing materials in accordance with local regulations.
2. Inspect the product to determine if any parts have been damaged or are missing.
3. If applicable, unfasten the product by removing any screws, bolts, or straps.  
For your personal safety, be careful when you handle nails and straps.
4. Contact your sales representative if anything is out of order.

## Product warranty

### Coverage

Grindex undertakes to remedy the following faults in products sold by Grindex under the following conditions:

- The faults are due to defects in design, materials or workmanship.
- The faults are reported to an Grindex representative within the warranty period.
- The product is used only under the conditions described in this manual.
- The monitoring equipment incorporated in the product is correctly connected and in use.

- All service and repair work is done by personnel authorized by Grindex.
- Genuine Grindex parts are used.

## Limitations

The warranty does not cover faults caused by the following:

- Deficient maintenance
- Improper installation
- Modifications or changes to the product and installation carried out without consulting Grindex
- Incorrectly executed repair work
- Normal wear and tear

Grindex assumes no liability for the following:

- Bodily injuries
- Material damages
- Economic losses

## Warranty claim

Grindex products are high-quality products with expected reliable operation and long life. However, should the need arise for a warranty claim, please contact your Grindex representative.

## Spare parts

Grindex guarantees that spare parts will be available for 10 years after the manufacture of this product has been discontinued.

## Safety



---

### WARNING:

- The operator must be aware of safety precautions to prevent physical injury.
- Any pressure-containing device can explode, rupture, or discharge its contents if it is over-pressurized. Take all necessary measures to avoid over-pressurization.
- Operating, installing, or maintaining the unit in any way that is not covered in this manual could cause death, serious personal injury, or damage to the equipment. This includes any modification to the equipment or use of parts not provided by Grindex. If there is a question regarding the intended use of the equipment, please contact an Grindex representative before proceeding.
- Installation, Operation, and Maintenance manuals clearly identify accepted methods for disassembling units. These methods must be adhered to. Trapped liquid can rapidly expand and result in a violent explosion and injury. Never apply heat to impellers, propellers, or their retaining devices to aid in their removal.



---

### CAUTION:

You must observe the instructions for installation, operation, and maintenance contained in this manual. Failure to do so could result in physical injury, damage, or delays.

---

## User safety

### General safety rules

These safety rules apply:

- Always keep the work area clean.
- Pay attention to the risks presented by gas and vapors in the work area.
- Avoid all electrical dangers. Pay attention to the risks of electric shock or arc flash hazards.
- Always bear in mind the risk of drowning, electrical accidents, and burn injuries.

### Safety equipment

Use safety equipment according to the company regulations. Use this safety equipment within the work area:

- Helmet
- Safety goggles, preferably with side shields
- Protective shoes
- Protective gloves
- Gas mask
- Hearing protection
- First-aid kit
- Safety devices

---

**NOTICE:**

Never operate a unit unless safety devices are installed. Also see specific information about safety devices in other chapters of this manual.

---

### Electrical connections

Electrical connections must be made by certified electricians in compliance with all international, national, state, and local regulations. For more information about requirements, see sections dealing specifically with electrical connections.

### Hazardous liquids

The product is designed for use in liquids that can be hazardous to your health. Observe these rules when you work with the product:

- Make sure that all personnel who work with biologically hazardous liquids are vaccinated against diseases to which they may be exposed.
- Observe strict personal cleanliness.

### Wash the skin and eyes

Do the following if chemicals or hazardous fluids have come into contact with your eyes or your skin:

<b>If you need to wash your...</b>	<b>Then...</b>
Eyes	<ol style="list-style-type: none"><li>1. Hold your eyelids apart forcibly with your fingers.</li><li>2. Rinse the eyes with eyewash or running water for at least 15 minutes.</li><li>3. Seek medical attention.</li></ol>

<b>If you need to wash your...</b>	<b>Then...</b>
Skin	<ol style="list-style-type: none"> <li>1. Remove contaminated clothing.</li> <li>2. Wash the skin with soap and water for at least one minute.</li> <li>3. Seek medical attention, if required.</li> </ol>

## Environmental safety

### The work area

Always keep the station clean to avoid and/or discover emissions.

### Recycling guidelines

Always recycle according to the guidelines listed below:

1. Follow local laws and regulations regarding recycling if the unit or parts are accepted by an authorized recycling company.
2. If the first guideline is not applicable, then return the unit or parts to the nearest Grindex representative.

### Waste and emissions regulations

Observe these safety regulations regarding waste and emissions:

- Dispose appropriately of all waste.
- Handle and dispose of the processed liquid in compliance with applicable environmental regulations.
- Clean up all spills in accordance with safety and environmental procedures.
- Report all environmental emissions to the appropriate authorities.

### Electrical installation

For electrical installation recycling requirements, consult your local electric utility.

# Transportation and Storage

## Transportation guidelines

### Precautions

---



**WARNING:**

- Stay clear of suspended loads.
  - Observe accident prevention regulations in force.
- 

### Position and fastening

The pump can be transported either horizontally or vertically. Make sure that the product is securely fastened during transportation, and cannot roll or fall over.

### Lifting

---



**WARNING:**

- Crush hazard. The unit and the components can be heavy. Use proper lifting methods and wear steel-toed shoes at all times.
  - Lift and handle the product carefully, using suitable lifting equipment.
  - The product must be securely harnessed for lifting and handling. Use eyebolts or lifting lugs if available.
  - Always lift the unit by its lifting handle. Never lift the unit by the motor cable or by the hose.
  - Do not attach sling ropes to shaft ends.
- 

## Storage guidelines

### Storage location

The product must be stored in a covered and dry location free from heat, dirt, and vibrations.

---

**NOTICE:**

- Protect the product against humidity, heat sources, and mechanical damage.
  - Do not place heavy weights on the packed product.
- 

### Freezing precautions

The pump is frost-proof while operating or immersed in liquid, but the impeller/propeller and the shaft seal may freeze if the pump is lifted out of the liquid into a surrounding temperature below freezing.

Follow these guidelines to avoid freezing damage:

<b>When</b>	<b>Guideline</b>
Before storage	<ul style="list-style-type: none"> <li>• The pump must be allowed to run for a short time after raising it to discharge remaining pumped liquid.</li> <li>• The discharge opening must be covered in a suitable way, or placed facing down so that any still remaining pumped liquid runs out.</li> <li>• If present, the cooling jacket must be drained manually by opening the air vent screws at the top of the cooling jacket.</li> </ul>
After storage	<p data-bbox="748 476 1471 554">If the impeller/propeller is frozen, it must be thawed by immersing the pump in liquid before operating the pump.</p> <p data-bbox="748 569 1471 644"><b>NOTICE:</b> Never use a naked flame to thaw the unit.</p>

## Long-term storage

If the pump is stored more than 6 months, the following apply:

- Before operating the pump after storage, it must be inspected with special attention to the seals and the cable entry.
- The impeller/propeller must be rotated every other month to prevent the seals from sticking together.

# Product Description

## Products included

Pump model	Approvals
Micro, 8121.210	Standard

## Pump design

The pump is submersible, and driven by an electric motor.

### Intended use



#### **WARNING:**

In explosive or flammable environments, only use Ex- or MSHA-approved pumps.

For information about pH, see [Application limits](#) (page 28).

### Particle size

The pump can handle liquid containing particles that correspond to the holes in the strainer.

Number of holes	Hole dimensions
96	11×5 mm (0.43×0.2 in.)

### Pressure class

N Medium head

### Impeller type

Wear resistant

## Monitoring equipment

The following applies to the monitoring equipment of the pump:

- The stator incorporates thermal contacts connected in series that activate the alarm at overtemperature.
- The thermal contacts open at 135°C (275°F).

## Level regulators

### About level regulators

Starting and stopping the pump at different water levels can be manual or automatic. If automatic start and stop is required, a level regulator can be ordered (as an option). The option is only available for standard pumps.

### Features

Below are some of the features of the level regulators:

- The level regulator can be set at different operating levels by adjusting the length of cable.
- A clamping bracket situated at the lifting handle holds the level regulator cable in place.
- If continuous pumping is required, the level regulator can be placed in a special rubber bracket on the discharge connection to eliminate the level regulator function.

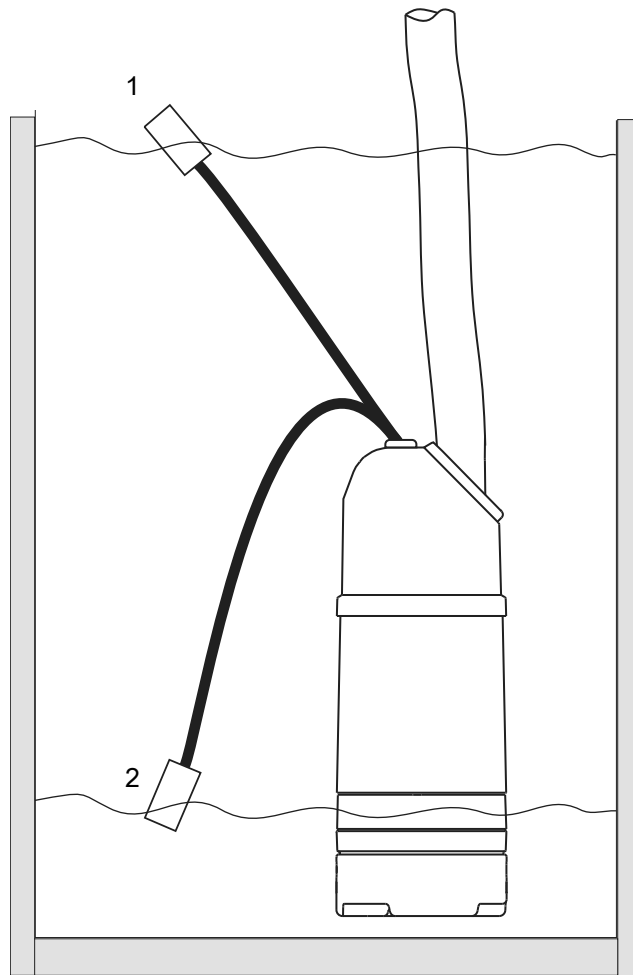
**Illustration**

1. On
2. Off

**Figure 1: The functionality of the level regulator**

## The data plate

### Introduction

The data plate is a metal label located on the main body of the pump. The data plate lists key product specifications.

### The data plate

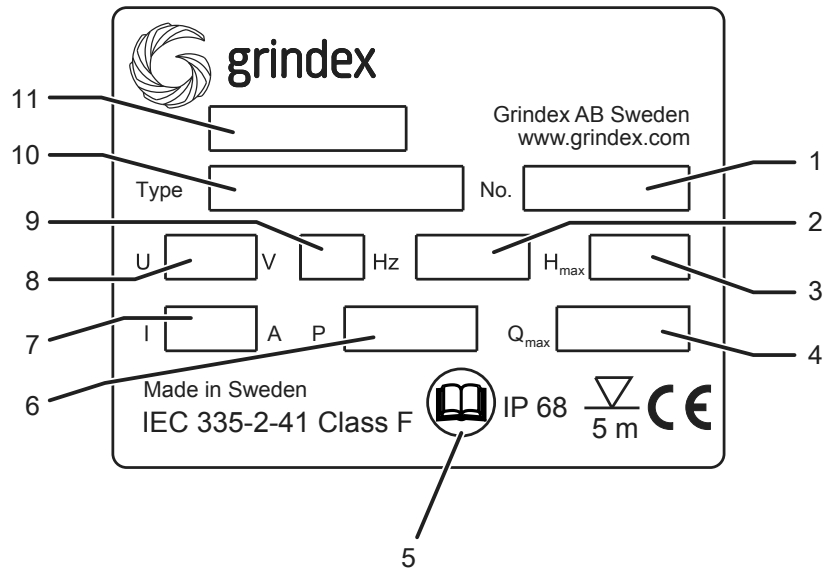

1. Serial number
2. Product weight
3. Maximum head
4. Maximum capacity
5. Read installation manual
6. Output power
7. Rated current
8. Rated voltage
9. Frequency
10. Product number
11. Pump model

# Installation

## Install the pump



### WARNING:

- Before installing the pump, check that the cable and cable entry have not been damaged during transportation.
- Make sure that the pump cannot roll or fall over and injure people or damage property.

### NOTICE:

- Never force piping to make a connection with a pump.

These requirements apply:

- Use the pump dimensional drawing in order to ensure proper installation.
- Provide a suitable barrier around the work area, for example, a guard rail.
- Check the explosion risk before you weld or use electric hand tools.
- Remove all debris from the inlet piping system before you install the pump.

## Sedimentation prevention

In order to avoid sedimentation when the pumped liquid contains solid particles, the velocity of the liquid in the discharge line must exceed a certain value. Choose applicable minimum velocity from the table, and choose proper dimension of the discharge line accordingly.

Mixture	Minimum velocity, meter per second (feet per second)
Water + coarse gravel	4 (13)
Water + gravel	3.5 (11)
Water + sand, particle size <0.6 mm (0.024 in.)	2.5 (8.2)
Water + sand, particle size <0.1 mm (0.004 in.)	1.5 (4.9)

For more permanent installations with a heavily contaminated pumped liquid, a settling pump-sump is recommended.

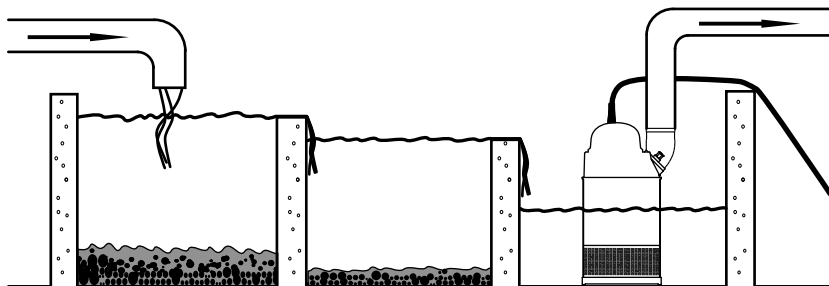
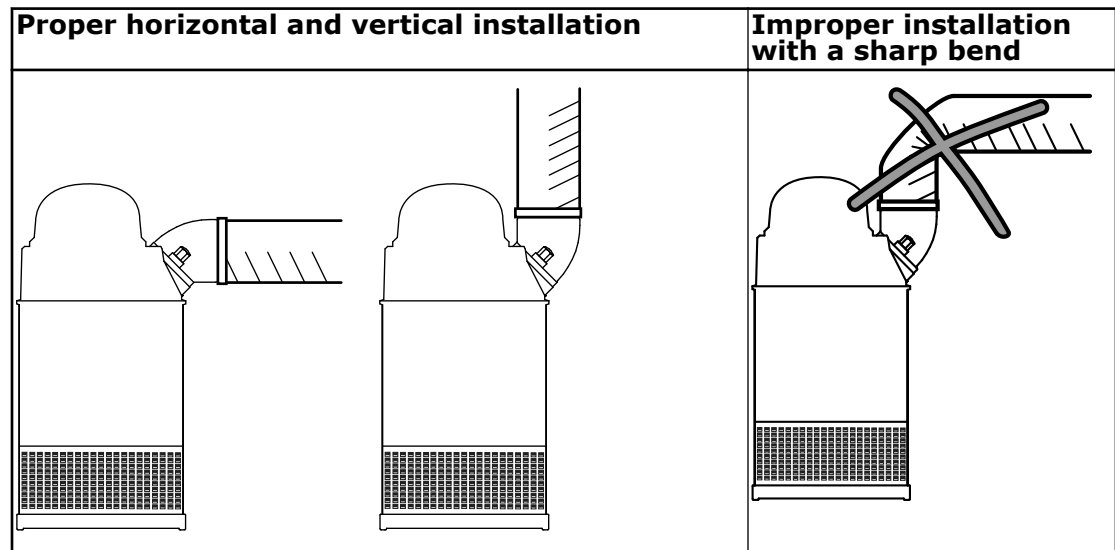

Figure 2: Settling pump-sump

## Discharge line requirements

The discharge line can be run vertically or horizontally, but must be without sharp bends.



## Fasteners



### WARNING:

- Only use fasteners of the proper size and material.
- Replace all corroded fasteners.
- Make sure that all fasteners are properly tightened and that there are no missing fasteners.

## Install

The pump is transportable and intended to operate either completely or partially submerged in the pumped liquid. The pump is equipped with a connection for hose or pipe.

These requirements and instructions only apply when the installation is made according to the dimensional drawing.

1. Run the cable so that it has no sharp bends, is not pinched, and cannot be sucked into the pump inlet.
2. Connect the discharge line.

The discharge line can be run vertically or horizontally, but must be without sharp bends.

3. Lower the pump into the sump.

The cable must not be used for this purpose. You should attach a rope or similar to the handle or the eyebolts for lowering and lifting the pump.

Heavier pumps must be lifted and lowered down by crane. Suspend the pump by the lifting handle or the eyebolts with chains or wires.

4. Place the pump on the base and make sure it cannot fall over or sink.

The base should consist of a plank, a bed of coarse gravel, or a cut-down and perforated oil drum.

Alternatively, the pump can be suspended with a lifting chain just above the sump bottom. Make sure that the pump cannot rotate at startup or during operation.

5. Connect the motor cable and the starter and monitoring equipment according to the separate instructions.

Make sure that the impeller rotation is correct. For more information, see [Check the impeller rotation](#) (page 18).

## Make the electrical connections

### General precautions



#### Electrical Hazard:

- A certified electrician must supervise all electrical work. Comply with all local codes and regulations.
- Before starting work on the pump, make sure that the pump and the control panel are isolated from the power supply and cannot be energized. This applies to the control circuit as well.
- Leakage into the electrical parts can cause damaged equipment or a blown fuse. Keep the end of the motor cable above the liquid level.
- Make sure that all unused conductors are insulated.
- There is a risk of electrical shock or explosion if the electrical connections are not correctly carried out or if there is fault or damage on the product.



#### CAUTION:

If the pump is equipped with automatic level control and/or internal contactor, there is a risk of sudden restart.

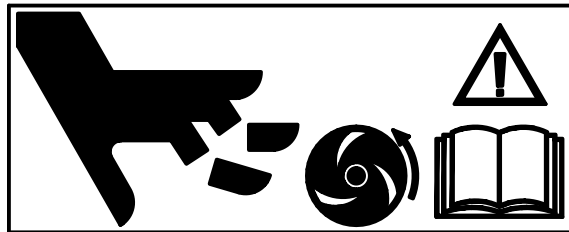

### Requirements

These general requirements apply for electrical installation:

- The supply authority must be notified before installing the pump if it will be connected to the public mains. When the pump is connected to the public power supply, it may cause flickering of incandescent lamps when started.
- The mains voltage and frequency must agree with the specifications on the data plate. If the pump can be connected to different voltages, the connected voltage is specified by a yellow sticker close to the cable entry.
- The fuses, short-circuit, and circuit breakers must have the proper rating, and the pump overload protection (motor protection breaker) must be connected and set to the rated current according to the data plate and if applicable the cable chart. The starting current in direct-on-line starting can be up to six times higher than the rated current.
- The fuse rating and the cables must be in accordance with the local rules and regulations.
- If intermittent operation is prescribed, the pump must be provided with monitoring equipment supporting such operation.
- The thermal contacts must be in use.

## Cables

These are the requirements to follow when you install cables:

- The cables must be in good condition, not have any sharp bends, and not be pinched.
- The sheathing must not be damaged and must not have indentations or be embossed (with markings, etc.) at the cable entry.
- The minimum bending radius must not be below the accepted value.
- If the outer sheath of the cable is damaged, then replace the cable. Contact a Grindex service shop.
- The voltage drop in long cables must be taken into account. The drive unit's rated voltage is the voltage measured at the terminal board in the upper part of the pump.

## Earthing (Grounding)

---



### Electrical Hazard:

- You must earth (ground) all electrical equipment. This applies to the pump equipment, the driver, and any monitoring equipment. Test the earth (ground) lead to verify that it is connected correctly.
  - If the motor cable is jerked loose by mistake, the earth (ground) conductor should be the last conductor to come loose from its terminal. Make sure that the earth (ground) conductor is longer than the phase conductors. This applies to both ends of the motor cable.
  - Risk of electrical shock or burn. You must connect an additional earth-(ground-) fault protection device to the earthed (grounded) connectors if persons are likely to come into physical contact with the pump or pumped liquids.
- 

## Check the earth (ground) continuity

---

### NOTICE:

The two earth (ground) conductors in the pump are connected via the same conductor to earth (ground).

---

Check the earth (ground) continuity.

Measure between the earth (ground) conductor in the motor cable and one of the screws securing the strainer.

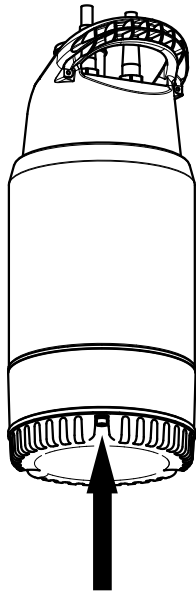

## Electrical connection

### Color definition

<b>Bl</b>	Blue
<b>Bla</b>	Black
<b>Br</b>	Brown
<b>Gr/Ye</b>	Green/Yellow
<b>Wh</b>	White

### With level regulator

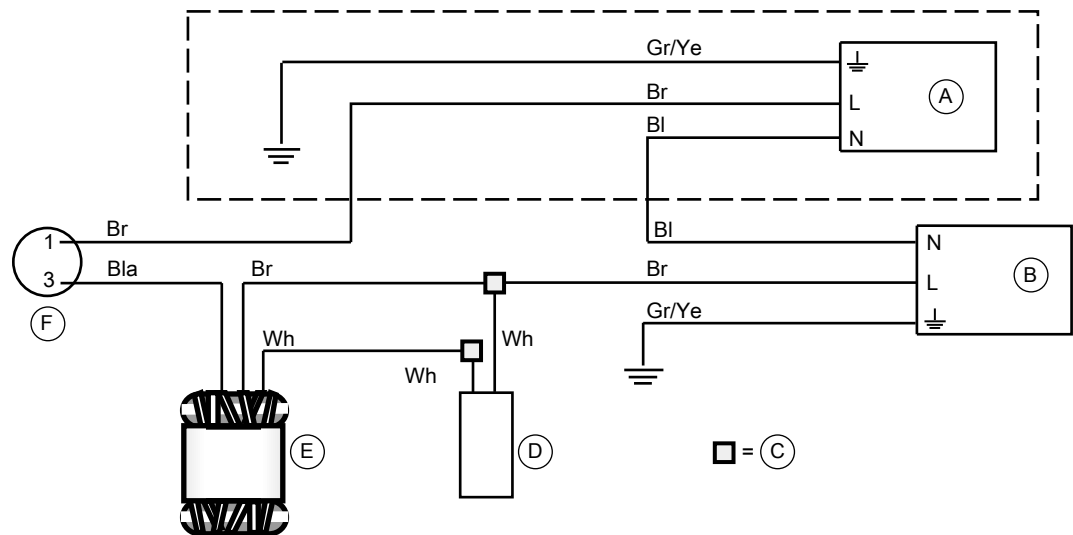

<b>A</b>	Level regulator
<b>B</b>	Plug contact
<b>C</b>	Connector
<b>D</b>	Capacitor
<b>E</b>	Stator

**F** Motor protection

**Without level regulator**

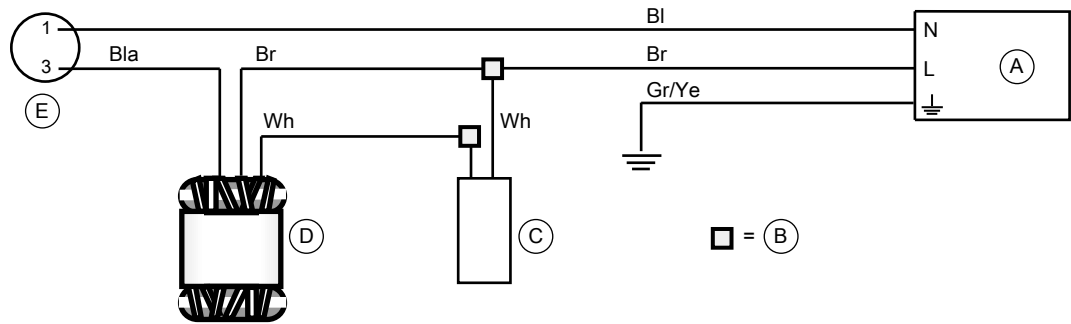

- A** Plug contact
- B** Connector
- C** Capacitor
- D** Stator
- E** Motor protection

**Check the impeller rotation**



**WARNING:**

The starting jerk can be powerful.

1. Start the motor.
2. Stop the motor.
3. Check that the impeller rotates in the correct direction.

The correct direction of impeller rotation is clockwise when you look at the pump from above. When started, the pump will react in the opposite direction to the impeller rotation.

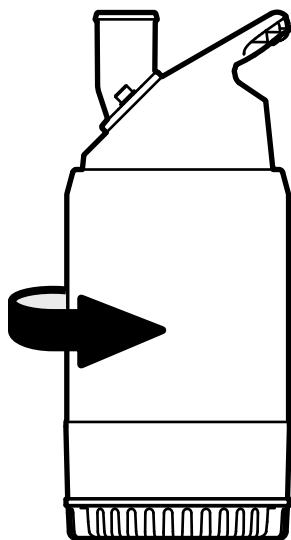

**Figure 3: Start reaction**

4. If the impeller rotates in the wrong direction, then do the following:
  - If the motor has a 1-phase connection, then contact the local Grindex shop.

# Operation

## Precautions

- Never operate the pump without safety devices installed.
- Never operate the pump with the discharge valve closed.
- Make sure that all safety guards are in place and secure.
- Make sure you have a clear path of retreat.
- Never work alone.
- Beware of the risk of a sudden start if the product is used with an automatic level control and/or internal contactor.

## Distance to wet areas

---



**Electrical Hazard:**

Risk of electrical shock when pumping or mixing near a lake, jetties, beaches, ponds, fountains, or similar. There must be a safety distance of at least 20 m (65 ft.) between the person and the product if the person is in contact with the pumped or mixed liquid.

---

---



**Electrical Hazard:**

Risk of electrical shock. This pump has not been investigated for use in swimming pools. If used in connection with swimming pools special safety regulations apply.

---

## Noise level

---

**NOTICE:**

The noise level of the product is lower than 70 dB. However, the noise level of 70 dB may be exceeded in some installations and at certain operating points on the performance curve. Make sure that you understand the noise level requirements in the environment where the pump is installed. Failure to do so may result in hearing loss or violation of local laws.

---

## Start the pump

---



**WARNING:**

- If you need to work on the pump, make sure that it is isolated from the power supply and cannot be energized.
  - Make sure that the pump cannot roll or fall over and injure people or damage property.
  - In some installations, the pump and the surrounding liquid may be hot. Bear in mind the risk of burn injuries.
  - Make sure nobody is close to the pump when it is started. The pump will jerk in the opposite direction of the impeller rotation.
- 
- 

**NOTICE:**

Make sure that the rotation of the impeller is correct. For more information, see Check the impeller rotation.

---

1. Check the oil level in the oil housing.
2. Remove the fuses or open the circuit breaker, and check that the impeller can be rotated freely.
3. Check that the monitoring equipment (if any) works.
4. Check that the impeller rotation is correct.
5. Start the pump.

## **Clean the pump**

The pump must be cleaned if it has been running in very dirty water. If clay, cement or other similar dirt is left in the pump it may clog the impeller and seal, preventing the pump from working.

Let the pump run for a while in clean water, or flush it through the discharge connection.

# Maintenance

## Precautions



### WARNING:

- Always follow safety guidelines when working on the pump. See [Introduction and Safety](#) (page 3).
- Disconnect and lock out electrical power before installing or servicing the pump.
- Make sure that the pump cannot roll or fall over and injure people or damage property.
- Rinse the pump thoroughly with clean water before working on the pump.
- Rinse the components in water after dismantling.

Make sure that you follow these requirements:

- Check the explosion risk before you weld or use electrical hand tools.
- Allow all system and pump components to cool before you handle them.
- Make sure that the product and its components have been thoroughly cleaned.
- Do not open any vent or drain valves or remove any plugs while the system is pressurized. Make sure that the pump is isolated from the system and that pressure is relieved before you disassemble the pump, remove plugs, or disconnect piping.

## Maintenance guidelines

During maintenance and before reassembly, always remember to perform these tasks:

- Clean all parts thoroughly, particularly O-ring grooves.
- Change all O-rings, gaskets, and seal washers.
- Lubricate all springs and O-rings with grease.

During reassembly, always make sure that existing index markings are in line.

## Torque values

### Screw and nuts

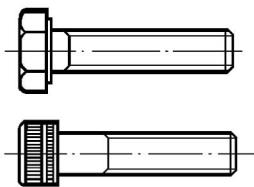

Stainless steel, A2 and A4											
	Property class	M4	M5	M6	M8	M10	M12	M16	M20	M24	M30
Torque, Nm (ft-lbs)	70 +80 <sup>1</sup>	2.7 (2)	5.4 (4)	9.3 (6.9)	22 (16)	44 (32)	76 (56)	187 (138)	364 (268)	629 (464)	1240 (915)

Carbon steel and alloyed steel											
Torque, Nm (ft- lbs)	8.8	2.9 (2.1)	5.7 (4.2)	9.8 (7.2)	24 (18)	47 (35)	81(60)	194 (143)	385 (285)	665 (490)	1310 (966)
	10.9	4.0 (2.9)	8.1 (6)	14 (10.3)	33 (24.3)	65 (48)	114 (84)	277 (204)	541 (399)	935 (689)	1840 (1357)
	12.9	4.9 (3.6)	9.7 (7.2)	17 (12.5)	40 (30)	79 (58)	136 (100)	333 (245)	649 (480)	1120 (825)	2210 (1630)

### Screws with countersunk heads

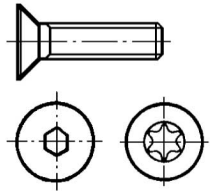

Stainless steel, A2 and A4										
	Property class	M4	M5	M6	M8	M10	M12	M16	M20	M24
Torque, Nm (ft- lbs)	70 +80 <sup>1</sup>	1.2 (0.9)	2.7 (2)	5.4 (4)	9.3 (6.9)	22 (16)	44 (32)	76 (56)	120 (88)	187 (138)
Carbon steel and alloyed steel										
Torque, Nm (ft- lbs)	8.8	2.3 (1.7)	4.6 (3.4)	7.8 (5.8)	19 (14)	38 (28)	65 (48)	158 (116)	308 (228)	532 (392)
	10.9	3.2 (2.4)	6.5 (4.8)	11(8)	26 (19)	52 (38)	91 (67)	222 (164)	433 (320)	748 (552)
	12.9	3.9 (2.9)	7.8 (5.8)	14 (10.3)	32 (23.6)	63 (46)	109 (80)	266 (196)	519 (383)	896 (661)

## Service

Regular service of the pump ensures more reliable operation.

### Inspection

The pump should be inspected at least twice a year, more frequently under severe operating conditions.

### Screw tightening

During assembly or service of the pumps we recommend that the screws be tightened to approximately 6–8 Nm (4.5–6 ft-lbs). The tightening torque ensures that the parts are correctly fastened and that the pumps will operate as intended.

#### NOTICE:

Make sure that the oil-plug and securing screws for strainer or pump housing are not tightened too hard.

To maintain screw tightness, use some mineral oil on all non-stainless steel screws.

When using stainless steel screws on stainless steel parts, apply Aral Degol GS 460 or National Chemseal Thread-Eze lubricant in order to prevent the screws from seizing.

<sup>1</sup> Property class 70 is torque tightened as class 80.

# Troubleshooting

## Introduction

Follow these guidelines when troubleshooting the pump:

- Disconnect and lock out the power supply except when conducting checks that require voltage.
- Make sure that no one is near the pump when the power supply is reconnected.
- When troubleshooting electrical equipment, use the following:
  - Universal instrument multimeter
  - Test lamp (continuity tester)
  - Wiring diagram

## The pump does not start



**WARNING:**

Always disconnect and lock out power before servicing to prevent unexpected startup. Failure to do so could result in death or serious injury.

**NOTICE:**

Do NOT override the motor protection repeatedly if it has tripped. Doing so may result in equipment damage.

Cause	Remedy
An alarm signal has been triggered on the control panel.	Check that: <ul style="list-style-type: none"> <li>• The impeller rotates freely.</li> <li>• The sensor indicators do not indicate an alarm.</li> <li>• The overload protection is not tripped.</li> </ul> If the problem still persists: Contact the local Grindex service shop.
The pump does not start automatically, but can be started manually.	Check that: <ul style="list-style-type: none"> <li>• The start level regulator is functioning. Clean or replace if necessary.</li> <li>• All connections are intact.</li> <li>• The relay and contactor coils are intact.</li> <li>• The control switch (Man/Auto) makes contact in both positions.</li> </ul> Check the control circuit and functions.
The installation is not receiving voltage.	Check that: <ul style="list-style-type: none"> <li>• The main power switch is on.</li> <li>• There is control voltage to the start equipment.</li> <li>• The fuses are intact.</li> <li>• There is voltage in all phases of the supply line.</li> <li>• All fuses have power and that they are securely fastened to the fuse holders.</li> <li>• The overload protection is not tripped.</li> <li>• The motor cable is not damaged.</li> </ul>
The impeller is stuck.	Clean:

Cause	Remedy
	<ul style="list-style-type: none"> <li>• The impeller</li> <li>• The sump in order to prevent the impeller from clogging again.</li> </ul>

If the problem persists, contact the local Grindex service shop. Always state the product number and the serial number of your pump when you contact Grindex, see [Product Description](#) (page 10).

## The pump does not stop when a level sensor is used



**WARNING:**

Always disconnect and lock out power before servicing to prevent unexpected startup. Failure to do so could result in death or serious injury.

Cause	Remedy
The pump is unable to empty the sump to the stop level.	Check that: <ul style="list-style-type: none"> <li>• There are no leaks from the piping and/or discharge connection.</li> <li>• The impeller is not clogged.</li> <li>• The non-return valve(s) are functioning properly.</li> <li>• The pump has adequate capacity. For information: Contact the local Grindex service shop.</li> </ul>
There is a malfunction in the level-sensing equipment.	<ul style="list-style-type: none"> <li>• Clean the level regulators.</li> <li>• Check the functioning of the level regulators.</li> <li>• Check the contactor and the control circuit.</li> <li>• Replace all defective items.</li> </ul>
The stop level is set too low.	Raise the stop level.

If the problem persists, contact the local Grindex service shop. Always state the product number and the serial number of your pump when you contact Grindex, see [Product Description](#) (page 10).

## The pump starts-stops-starts in rapid sequence

Cause	Remedy
The pump starts due to back-flow which fills the sump to the start level again.	Check that: <ul style="list-style-type: none"> <li>• The distance between the start and stop levels is not too small.</li> <li>• The non-return valve(s) work(s) properly.</li> <li>• The rinser is not too long without a non-return valve.</li> </ul>
The self-holding function of the contactor malfunctions.	Check: <ul style="list-style-type: none"> <li>• The contactor connections.</li> <li>• The voltage in the control circuit in relation to the rated voltages on the coil.</li> <li>• The functioning of the stop-level regulator.</li> <li>• Whether the voltage drop in the line at the starting surge causes the contactor's self-holding malfunction.</li> </ul>

If the problem persists, contact the local Grindex service shop. Always state the product number and the serial number of your pump when you contact Grindex, see [Product Description](#) (page 10).

## The pump runs but the motor protection trips



**WARNING:**

Always disconnect and lock out power before servicing to prevent unexpected startup. Failure to do so could result in death or serious injury.

**NOTICE:**

Do NOT override the motor protection repeatedly if it has tripped. Doing so may result in equipment damage.

Cause	Remedy
The impeller is difficult to rotate by hand.	<ul style="list-style-type: none"> <li>• Clean the impeller.</li> <li>• Clean out the sump.</li> <li>• Check that the impeller is properly trimmed.</li> </ul>
The phase currents vary, or they are too high.	Contact the local Grindex service shop.
The insulation between the phases and ground in the stator is defective.	<ol style="list-style-type: none"> <li>1. Use an insulation tester. With a 1000 V DC megger, check that the insulation between the phases and between any phase and ground is &gt; 5 megohms.</li> <li>2. If the insulation is less: Contact the local Grindex service shop.</li> </ol>
The density of the pumped fluid is too high.	<p>Make sure that the maximum density is 1100 kg/m<sup>3</sup> (9.2 lb/US gal)</p> <ul style="list-style-type: none"> <li>• Change to a more suitable pump.</li> <li>• Contact the local Grindex service shop.</li> </ul>
The ambient temperature exceeds the maximum ambient temperature.	The pump must not be used for such an application.
There is a malfunction in the overload protection.	Replace the overload protection.

If the problem persists, contact the local Grindex service shop. Always state the product number and the serial number of your pump when you contact Grindex, see [Product Description](#) (page 10).

## The pump delivers too little or no water



**WARNING:**

Always disconnect and lock out power before servicing to prevent unexpected startup. Failure to do so could result in death or serious injury.

**NOTICE:**

Do NOT override the motor protection repeatedly if it has tripped. Doing so may result in equipment damage.

<b>Cause</b>	<b>Remedy</b>
The impeller rotates in the wrong direction.	<ul style="list-style-type: none"> <li>• If it is a 1-phase pump: Contact the local Grindex service shop.</li> </ul>
One or more of the valves are set in the wrong positions.	<ul style="list-style-type: none"> <li>• Reset the valves that are set in the wrong position.</li> <li>• Replace the valves, if necessary.</li> <li>• Check that all valves are correctly installed according to media flow.</li> <li>• Check that all valves open correctly.</li> </ul>
The impeller is difficult to rotate by hand.	<ul style="list-style-type: none"> <li>• Clean the impeller.</li> <li>• Clean out the sump.</li> <li>• Check that the impeller is properly trimmed.</li> </ul>
The pipes are obstructed.	Clean out the pipes to ensure a free flow.
The pipes and joints leak.	Find the leaks and seal them.
There are signs of wear on the impeller, pump, and casing.	Replace the worn parts.
The liquid level is too low.	<ul style="list-style-type: none"> <li>• Check that the level sensor is set correctly.</li> <li>• Depending on the installation type, add a means for priming the pump, such as a foot valve.</li> </ul>

If the problem persists, contact the local Grindex service shop. Always state the product number and the serial number of your pump when you contact Grindex, see [Product Description](#) (page 10).

# Technical Reference

## Application limits

Data	Description
Media (liquid) temperature	5–35°C (41–95°F)
pH of the pumped media (liquid)	3–9
Media (liquid) density	Maximum density: 1100 kg/m <sup>3</sup> (9.2 lb. per US gal.)
Depth of immersion	5 m (16.5 ft.)
Other	For specific weight, current, voltage, power rating, and speed of the pump, see the data plate on the pump. For starting current, see <a href="#">Motor data</a> (page 28). For other applications, contact the nearest Grindex representative for information.

## Motor data

Feature	Description
Motor type	Squirrel-cage induction motor
Frequency	50 or 60 Hz
Supply	1-phase
Maximum starts per hour	30 evenly spaced starts per hour
Code compliance	IEC 60034-1
Rated output variation	±10%
Voltage variation without overheating	±10%, provided that it does not run continuously at full load
Voltage imbalance tolerance	2%
Stator insulation class	F (155°C [310°F])

## Specific motor data

### 1-phase, 50 Hz

Motor type:

- 2,760 rpm
- 420 W (0.5 hp)

Voltage (V)	Rated current (A)	Starting current (A)
115	5.1	19
230	2.7	7.5
240	2.4	7.8

### 1-phase, 60 Hz

Motor type:

- 3,335 rpm
- 450 W (0.6 hp)

Voltage (V)	Rated current (A)	Starting current (A)
115	5.5	18
230	2.9	7

## Dimensions and weights

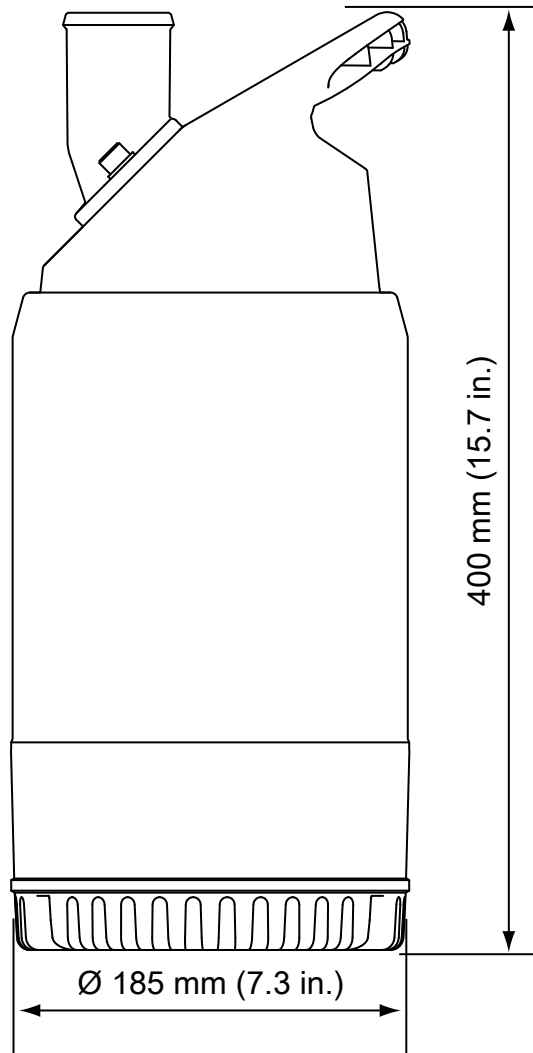

Weight without motor cable: 10 kg (22 lbs)

## Performance curves

### Standard

Pumps are tested in accordance with ISO 9906, HI level A.

**Micro**

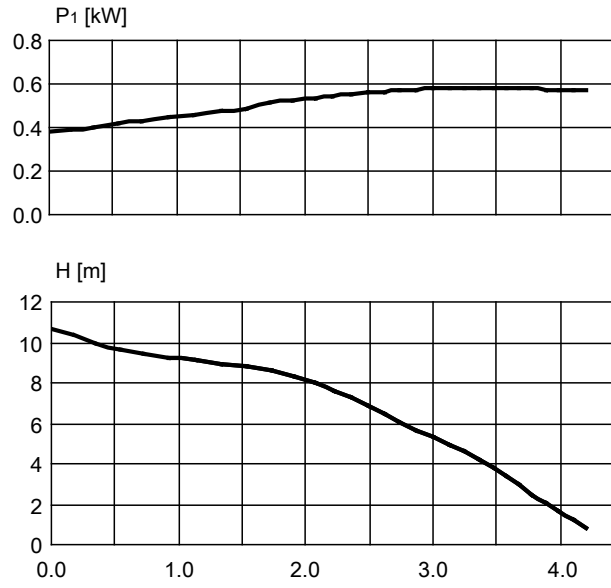

**Figure 4: 50 Hz**

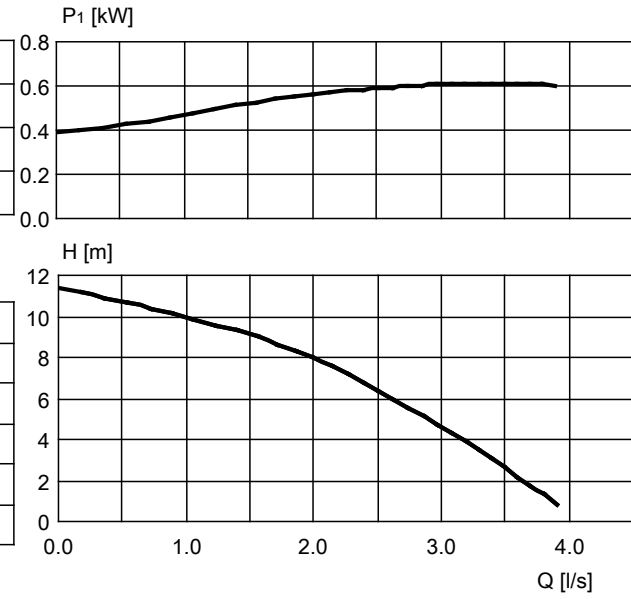

**Figure 5: 60 Hz**





Grindex  
Gesällvägen 33  
174 87 Sundbyberg  
Sweden  
Tel. +46-8-606 66 00  
Fax +46-8-745 53 28